

PAVING

# VersiFrame<sup>®</sup>

Aluminium Joist for Paver Support



**Creating Cities**  
Where Urban Meets Nature

## Our Innovation Your Solution

VersiFrame<sup>®</sup> Aluminium Joist is developed for use with VersiJack<sup>®</sup> height-adjustable pedestals to create a substructure for raised paving systems. It is designed to complement porcelain pavers and other types of flooring surfaces, allowing for an increased level of versatility and stability.

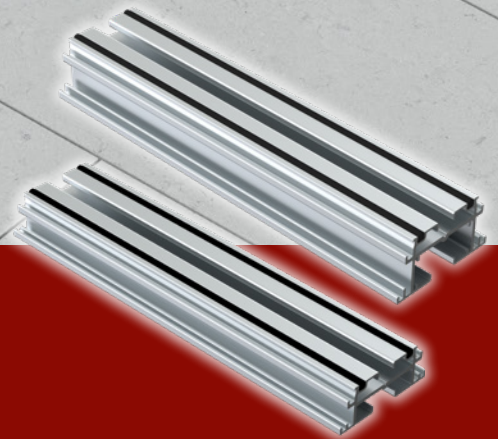

# VersiFrame®

VersiFrame® is an aluminium joist system developed to be used in conjunction with VersiJack® pedestals to construct a more stable and versatile substructure for raised pavers. It improves heat and sound insulation, facilitates rapid surface drainage and creates an easily accessible chamber to conceal mechanical and electrical services.

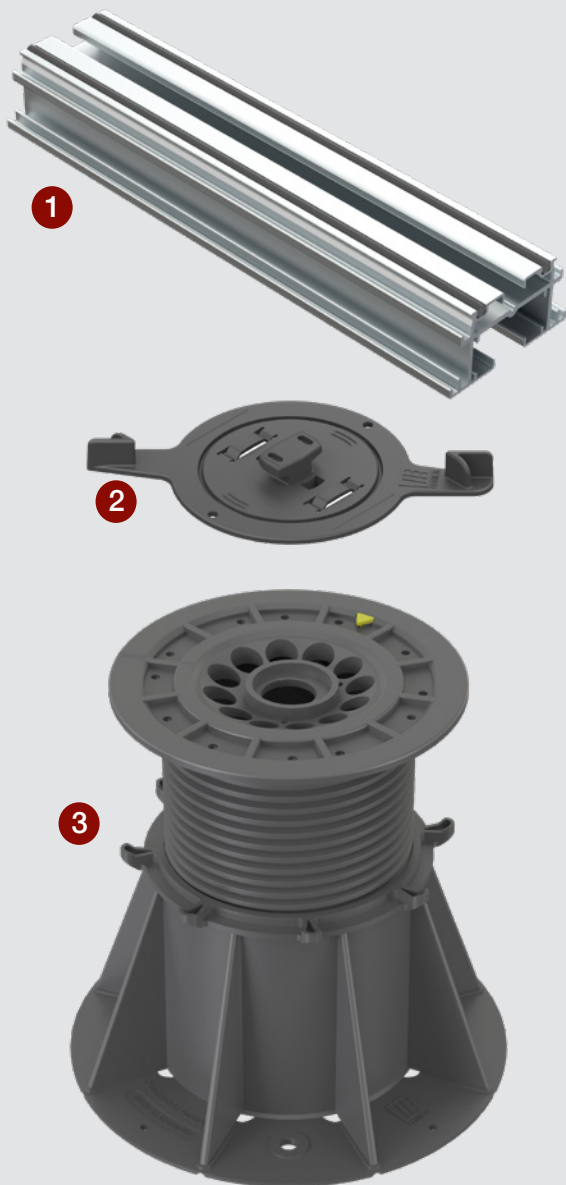

## About VersiFrame®

VersiFrame® comes in two sizes, 25 mm or 35 mm high. It is complemented by a comprehensive list of accessories to accommodate installations of various requirements.

VersiFrame® is connected to VersiJack® pedestals using an adaptor and once locked in place, the substructure prevents pedestals from unintended movement during installation, maintenance and everyday traffic atop the raised pavers.

VersiFrame® comes with two rubber strips on the surface of the joist to provide friction for pavers to minimise movement, and additional sound and vibration dampening.

### 1 VersiFrame® Aluminium Joist

VersiFrame® allows for a high level of versatility and stability in the arrangement of floor pavers with height-adjustable pedestals and an array of accessories that integrate cleverly to achieve the preferred design and to allow full edge support for pavers.

### 2 Joist Adaptor

Joist Adaptor is used to connect aluminium joists securely to the pedestal.

### 3 Pedestal

VersiJack® height-adjustable pedestals can be used with the VersiFrame® Aluminium Joist, offering a high strength, durable, and reliable substructure for paving installations.

# VersiFrame® Accessories

1



### Joist Spacer Tab

Joist Spacer Tab separates pavers by a gap of 3 mm, 4 mm, 8 mm and can be configured to accommodate different paver layouts.

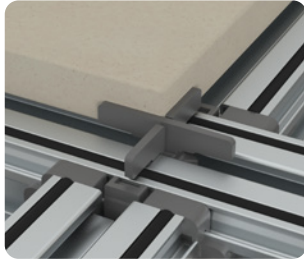

2



### Side Wall Spacer

Side Wall Spacer extends the end of a joist when it is a distance from the wall while ensuring a gap of 10 mm between pavers and the wall.



3



### End Wall Spacer

End Wall Spacer covers the end of a joist when it is against the wall while ensuring a gap of 10 mm between pavers and the wall.



4



### Perpendicular Joist Joiner

Perpendicular Joist Joiner allows one end of a joist to connect perpendicularly along the length of another joist.

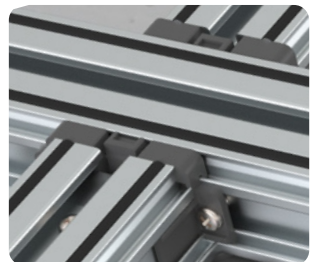

5

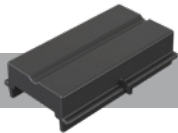

### Straight Joist Joiner

Straight Joist Joiner is a concealed joiner that connects 2 joists in a straight line.

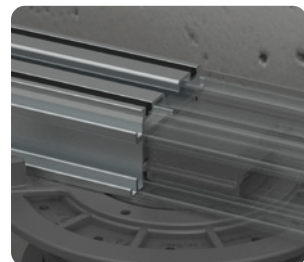

6



### End Restrainer

End restrainer ensures that pavers do not slip off by closing off the perimeter edge of the paving area.

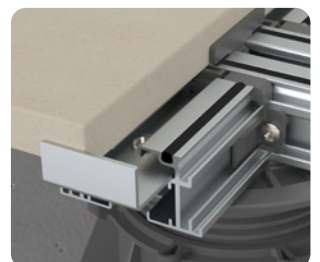

7



### Angled Joist Joiner

Angled Joist Joiner is a stainless steel joiner that connects 2 joists in a straight line or at an angle.

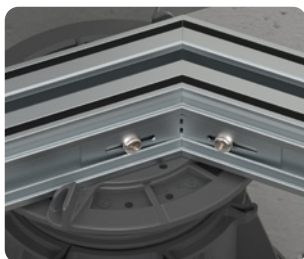

8

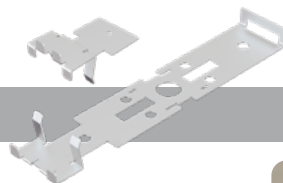

### Vertical Edge Clips

Vertical Edge Clips allow pavers to be installed upright to create a closed edge installation.



*\*only compatible with VF 35R*

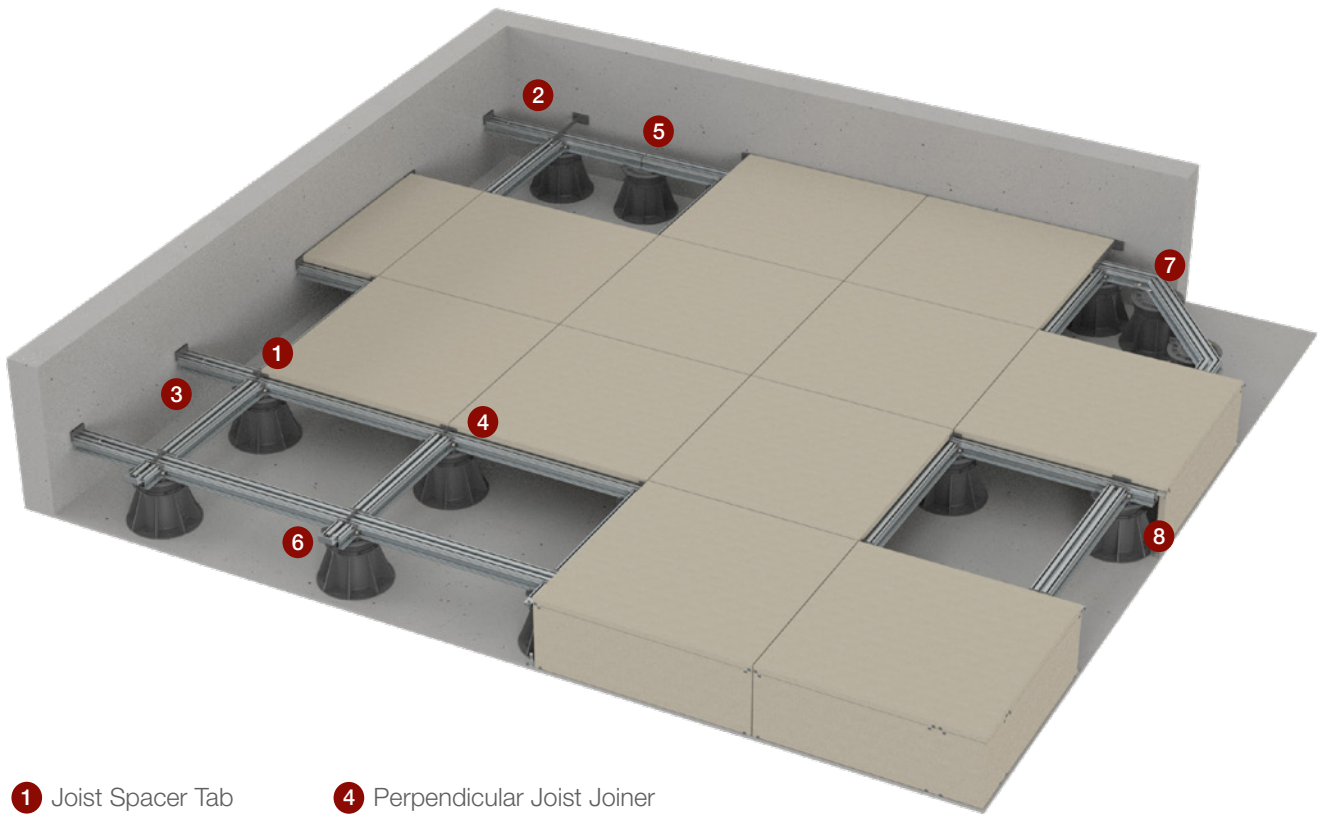

- 1 Joist Spacer Tab
- 2 Side Wall Spacer
- 3 End Wall Spacer
- 4 Perpendicular Joist Joiner
- 5 Straight Joist Joiner
- 6 End Restrainer
- 7 Angled Joist Joiner
- 8 Vertical Edge Clips

## Technical Specifications

	VersiFrame® 25R	VersiFrame® 35R
Material	Aluminium <sup>1</sup>	
Linear thermal expansion coefficient	2.34 x 10 <sup>-5</sup> K <sup>-1</sup>	
Supply length (m)	2.4	
Height (mm)	25	35
Design span along joist (mm)		
Live load <sup>2</sup> @ 3.0 kN/m <sup>2</sup>	600	900
Live load <sup>3</sup> @ 5.0 kN/m <sup>2</sup>	400	600
Biological / Chemical resistance	Unaffected by moulds and algae. Resistant to corrosion	

<sup>1</sup> A6063 T5

<sup>2</sup> Uniformly distributed live loads on residential raised floor balconies should not exceed 3.0 kN/m<sup>2</sup>.

<sup>3</sup> Uniformly distributed live loads on commercial raised floor areas should not exceed 5.0 kN/m<sup>2</sup>.



The Elmich security hologram ensures authenticity of the products.

**Distributed by:**

**Note:** The information provided in this brochure is based on current knowledge and experience and does not infer any legally binding assurance or warranty, expressed or implied. Intending purchasers should verify whether any changes to specifications or applications or otherwise have been made since the issue of this literature. Environmentally-friendly recycled materials are used in product manufacture wherever possible. Physical product properties including colour may differ due to source of raw materials used. Colour may also fade due to UV exposure. All components of the product are designed for specific application, design calculations and any variation and/or deviation therefrom shall be the responsibility of the specifier and/or user.



**ELMICH PTE LTD** [www.elmich.com](http://www.elmich.com)

Singapore: (+65) 6356 2800

info@elmich.com

Singapore | Australia | Germany | Malaysia | Switzerland | USA



Management System  
ISO 9001:2015  
ISO 14001:2015  
ISO 22301:2012  
www.tuv.com  
ID 9105067457

